

PHILIPS

VideoTracer

音视频记录仪

VTR8101



使用手册

User manual

目录

1	欢迎	5	7	拍照	12
1.1	产品特点	5	8	录音	13
2	重要须知	6	9	视频模式	14
2.1	安全	6	9.1	视频播放	14
3	您的音视频记录仪	7	10	照片模式	15
3.1	供货范围:	7	11	语音模式	16
3.2	主机概览:	7	11.1	语音播放	16
4	开始使用	8	12	设置模式	17
4.1	开 / 关机	8	12.1	录音设置	17
4.2	充电方法	8	12.2	录像设置	17
4.3	连接电脑	9	12.3	拍照设置	18
5	录像	10	12.4	系统设置	19
6	当前录像时长	11	13	背夹的装取	23

14	常见问题	24
14.1	无法启动音视频记录仪	24
14.2	显示时间 / 日期不正确	24
14.3	拍照 / 录像图像模糊, 不清楚	24
14.4	音视频记录仪无法录音或者录像	24
14.5	音视频记录仪无法播放录音或者录像	24
14.6	音视频记录仪死机后如何处理	24

15	技术参数	25
15.1	存储器	25
15.2	尺寸和重量	25
15.3	系统要求	25
15.4	录音	25
15.5	运行条件	25

1 欢迎

欢迎来到飞利浦世界！您能选择和购买飞利浦的产品，我们非常高兴。您可在我们的官方网站上获得飞利浦公司的全方位技术支持，如：使用手册、软件下载、保修信息等。

www.philips.com

1.1 产品特点

- 一键录音：仅仅按下录音键即可实现录音，再按一下录音键保存录音。
 - 一键录像：向上拨动录像键即可实现录像，向下拨动录像键保存录像。
 - 超大广角镜头，录像无死角。
 - F1.6 超大光圈镜头，进光量更充足，画面更清晰通透。
 - 星光级夜视，在低照度环境下仍然能够彩色成像，夜视清晰可见。
 - 拨动式开关，安全灵活，性能稳定可靠。
 - 字符叠加功能，所有视频和照片都附加时间、产品编号、使用者编号等信息，无法剪辑，更具法律证据效力。
 - 超长文件名，所有录像文件的文件名都包含产品编号、时间、使用者编号等信息，方便数据存档、检索。
- 录像资料自动分割保存，防止误操作造成资料丢失。
 - 外置存储卡，最大支持 128G。
 - 高清扬声器：采用高品质喇叭，无论播放录音文件或录像文件，都给人身临其境的享受。
 - 以常见的 MP3 格式录音。
 - 使用高速 USB 2.0 快速存取录音文件和数据。
 - 可作为大容量的 USB 存储设备，确保最大的兼容性。
 - 可调节任意角度的阻尼轴背夹，佩戴灵活可靠。

2 重要须知

2.1 安全



注意

- 请注意，切勿挤压电缆，特别是插头处。



小心

特别声明：使用本产品前请仔细阅读本说明书，如因人为操作或不可抗力因素而导致数据丢失，本公司一概不予负责。特别提醒用户小心操作，注意将资料另外备份。

3 您的音视频记录仪

3.1 供货范围：

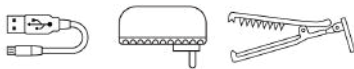

3.2 主机概览：

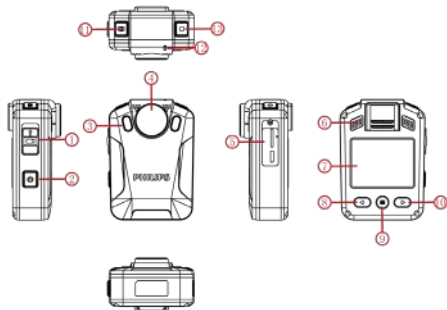

- | | |
|-------------------|-----------|
| ① 录像键 | ⑦ 扬声器 |
| ② 电源开/关 | ⑧ 上键/快退 |
| ③ 白光灯 | ⑨ 菜单键/返回键 |
| ④ 镜头 | ⑩ 下键/快进 |
| ⑤ USB接口/TF卡插口/复位键 | ⑪ 拍照键 |
| ⑥ 屏幕 | ⑫ 工作指示灯 |
| ⑬ 录音键 | |

4 开始使用

4.1 开 / 关机

注意

- 第一次使用机器时，请对该机器充电三小时以确保机器有电工作！

关机状态下，长按开机键 3s，本机立即自动开机，然后显示飞利浦图标，如下图所示：



然后机器进入预览界面，如下图所示，预览状态下，工作状态指示灯亮绿灯，在此界面短按菜单键，机器回到设置界面。长按“◀”或“▶”键放大或缩小预览界面，实现数码变焦功能。



提示

- 本机使用不可拆卸锂电池供电，如果长时间不使用音视频记录仪，请长按开关机键 3s 关掉机器。
- 如果音视频记录仪无法正常工作，请确认机器是否已没电。
- 机器工作过程中，请勿直接把外置卡拔出，否则会损坏文件或导致机器异常。
- 当电量指示标志为“”时，请及时充电。

4.2 充电方法

- 使用 USB 数据线将本机与 PC 相连接，充电过程中充电指示灯常亮绿色。
- 使用 USB 数据线将本机和出厂配备的充电器进行充电，充电过程中充电指示灯常亮绿色，充满后熄灭。

提示

- 本机充电可以使用关机充电和开机充电的方式，一般情况下，关机充满电需要 4 小时左右，开机充满电需要 6 小时左右（建议关机充电）。

4.3 连接电脑

音视频记录仪可作为大容量的 USB 存储设备，并可方便地与电脑相连，VTR8101 无须安装软件，音视频记录仪会自动显示为可移动设备。连接电脑图标如下图所示。



提示

- 在文件移入或移出机器时，请不要断开机器与电脑的连接。

5 录像

当您初次使用音视频记录仪录像时，请注意本节中的内容说明！

- (1) 在摄像预览状态下，向上拨动“录像”键开始录像，机器“滴”一声，状态指示灯将红灯闪烁。
- (2) 向下拨动“录像”键结束录像，机器“滴滴”两声，红色指示灯灭，并回到摄像预览状态界面，状态指示灯亮绿色。
- (3) 在预览界面长按“◀”或“▶”键放大或缩小，实现数码变焦功能。
- (4) 在黑夜或者光线暗的环境下录像时，长按录音键，照明灯将打开，补充光源。
- (5) 按“拍照”键可以抓拍当前摄录画面。
- (6) 录像过程中长按拍照键，文件将会标记为重要文件，循环录像打开时，标记的文件不会被删除。
- (7) 录像参考界面如下如所示：



录像界面说明



- | | |
|----------|----------|
| ① 录像分辨率 | ② 录像图标 |
| ③ 系统当前日期 | ④ ID号水印 |
| ⑤ 录像状态 | ⑥ 录像时长 |
| ⑦ 电量指示 | ⑧ 系统当前时间 |
| ⑨ 卡剩余容量 | ⑩ 卡标志 |

6 当前录像时长

注意

- 电池标记符显示空格时，表明低电。低电时系统会自动关机。如果正在录像或者录音，系统自动保存录音文件后再关机。电量不足时，请及时充电。低电关机时显示屏会有相应的提示，显示屏的提示图标如下所示。



提示

- 录像前，请先设置所需的录像参数。
- 请先删除一些不必要的文件再录。

7 拍照

当您初次使用音视频记录仪拍照时，请注意本节中的内容说明！
在摄像预览状态下，直接按拍照按键进行拍照，拍照时红色指示灯亮，并发出“咔嚓”一声，在黑夜或者光线暗的环境下拍摄需要开启机器补光灯进行拍摄（补光灯：在预览界面长按录音键可打开补光灯，再长按一次关闭补光灯，补光灯打开后，预览界面左上角显示灯图标，如图二）。在录像状态下，按下拍照按键可以抓拍当时摄录照片，拍照界面如图一。



图 1



图 2

8 录音

当您初次使用音视频记录仪录音时，请注意本节中的内容说明！

- (1) 在摄像预览状态按下“录音键”开始录音；工作状态指示灯将亮黄灯； 请将内置麦克风对准音源。
- (2) 按下“录音”键结束录音，并回到预览界面。

录音参考界面如下图所示：



录音界面说明



- ① 录音状态 ② 当前录音时长 ③ 电量指示



提示

- 录音前，请先设置所需的录音灵敏度。
- 请先删除一些不必要的文件再录。
- 请先测试录音，以确认音视频记录仪设置是否正确。
- 在录音或者录像过程中禁止直接将卡拔出，否则可能导致文件损坏。
- 录音或者录像时请勿断电，否则这会导致音视频记录仪故障，文件丢失或文件损坏等问题。
- 如果需要长时间使用，请在录音前充电。

9 视频模式

在摄像预览状态界面中，我们可以使用“◀”键进入查阅回放界面，按“◀”或“▶”键，选择视频选项，然后短按菜单键确认进入视频文件列表界面，视频文件列表参考界面如下图所示：



按“◀”或“▶”键选择需要播放的视频文件，短按菜单键进入视频播放界面，视频播放参考界面如下图所示：



文件的删除需通过连接电脑才可以进行。

录像文件播放界面说明：

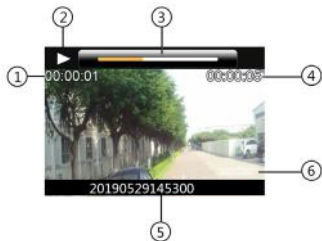

① 当前时长

② 播放状态

③ 进度条

④ 文件总时长

⑤ 文件名

⑥ ID水印

9.1 视频播放

- (1) 按“◀”或“▶”键，选择要播放的文件。
- (2) 按“菜单”键开始播放，工作状态指示灯将亮绿灯。
- (3) 播放过程中，按“菜单”键暂停播放，再次按下“菜单”键，将继续先前位置的播放。
- (4) 播放时短按“◀”或“▶”键，可选择2倍，4倍，8倍，16倍，32倍，64倍，128倍快退或快进当前正在播放的文件。

10 照片模式

在摄像预览状态界面中，我们可以使用“◀”键进入查阅回放界面，按“◀”或“▶”键，选择拍照选项，然后短按菜单键进入拍照文件列表界面，拍照文件列表参考界面如下图所示：



按“◀”或“▶”键选择需要播放的照片文件，短按菜单键进入照片浏览状态，按“◀”或“▶”键切换照片。

11 语音模式

在摄像预览状态下，你可以使用“◀”键进入查阅回放界面，按“◀”或“▶”键，选择录音选项，然后短按菜单键进入语音文件列表界面，语音文件列表参考界面如下图所示：



按“◀”或“▶”键选择需要播放的音频文件，短按菜单键进入语音播放界面，语音播放参考界面如下图所示：

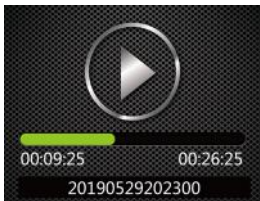

语音文件播放界面说明：

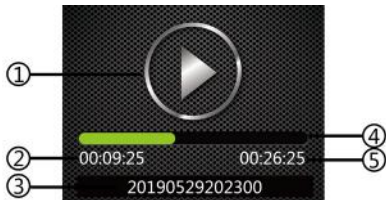

- ① 播放状态
- ② 当前播放时长
- ③ 时间文件名
- ④ 播放进度条
- ⑤ 文件总时长

11.1 语音播放

- (1) 按“◀”或“▶”键，选择要播放的文件。
- (2) 按“菜单”键开始播放，工作状态指示灯将亮绿灯。
- (3) 播放过程中，按菜单键暂停播放，再次按下菜单键，将继续播放。

12 设置模式

在摄像预览状态界面按下菜单键，系统将会进入设置界面。系统设置包括：录音设置，录像设置，拍照设置和系统设置。按“◀”或“▶”键选择，按菜单键进入选中的选项。长按“菜单”键返回预览界面。

12.1 录音设置

按“菜单”键进入设置模式，按“◀”或“▶”键选择录音设置菜单栏，按“菜单”键选择，弹出：高、中、低 选择不同的麦克灵敏度可以达到不同的录音效果。



12.2 录像设置

录像设置菜单栏包括：分辨率，视频质量，视频预录，视频延录。按“◀”或“▶”键选择所需设置的选项，然后按菜单键进入。

11.2.1 分辨率

录像分辨率有 1920×1080 30P、1440×1080 30P、1280×720 30P、848×480 30P 四个级别，多种录像分辨率选择，可满足大部分应用场合，按“◀”或“▶”键选择合适的分辨率，选择完成后按菜单键确定，长按菜单键可返回上一级菜单。

参考界面如下图所示：



12.2.2 视频质量

在视频质量菜单中有三种画质可供选择：“超精细，良好，正常”。根据不同的需求选择不同的画质效果，画质越好，相同录像时间所占的内存越大。

12.2.3 视频预录

使用视频预录功能，你可以提前录制事件触发前十几秒的画面，视频预录有关闭和打开两种选择，按“◀”或“▶”键进行选择，选择完成后按菜单键确定，长按菜单键可返回上一级菜单。

预录时间：约 16 秒。

12.2.4 视频延录

使用视频延录功能，你可以在按下按键保存录像后继续摄录设定的时间，视频延录设置关闭、5 秒、10 秒、20 分钟、30 分钟、五个选择，按“◀”或“▶”键进行选择，选择完成后按菜单键确定，长按菜单键可返回上一级菜单。

12.3 拍照设置

拍照设置菜单栏包括：照片大小，照片质量，连拍。按“◀”或“▶”键选择所需设置的选项，然后按菜单键进入。

12.3.1 照片大小

拍照照片的大小分为 34M、28M、23M、18M、13M、9M、6M、4M 这七个级别，按“◀”或“▶”键选择合适的分辨率，选择完成后按菜单键确定，长按菜单键可返回上一级菜单。参考界面如下图所示：



12.3.2 照片质量

在照片质量菜单中有三种画质可供选择：“超精细，良好，正常”。根据不同的需求选择不同的画质效果，画质越好，照片所占的内存越大。

12.3.3 连拍

连拍是指在取景预览模式下或在录像过程中，按一次拍照键相机能够连续拍摄照片。

在拍照设置菜单中，选择“连拍”菜单，再按菜单键进入连拍菜单。连拍设置可以设置关闭、3张、5张、10张、20张五个选择，按“◀”或“▶”键选择合适的连拍张数，选择完成后按菜单键确定，长按菜单键可返回上一级菜单。

12.4 系统设置

系统设置菜单栏包括：语言，默认设置，屏亮度，系统时间，自动关机，自动关屏，音量，车载模式，循环录像，车载录音，分段录像，按键音，指示灯，移动侦测，曝光补偿，ID号和系统信息。按“◀”或“▶”键选择所需设置的选项，然后按菜单键进入。

12.4.1 语言

在语言选择菜单中，你可以选择一种语言作为系统语言。语言选择参考界面如下：



12.4.2 默认设置

使用此功能，你可以重置机器的设置选项。

12.4.3 屏亮度

使用此功能，可以根据需要调节显示屏的亮度。屏亮度设置可以设置高、中、低三个级别，按“◀”或“▶”键选择合适的选项，选择完成后按菜单键确定，长按菜单键可返回上一级菜单。

12.4.4 系统时间

系统时间设置界面，参考图片如下：



在此界面下，按菜单键与“◀”或“▶”键可以设置实时时间。按“◀”或“▶”键改变相应位置数值，短按菜单键确认，长按菜单键返回上一级菜单。

12.4.5 自动关机

如果在设定的时间内没对机器做任何操作，系统将会自动关机。自动关机设置参考界面如下：



12.4.6 自动关屏

自动关屏时间有四种时长可供选择：关闭、30秒、1分钟、3分钟。如果在设定的时间内没对机器做任何操作，显示屏将会自动灭。如果选择“关闭”，显示屏将会常亮。

12.4.7 音量

使用此功能，你可以设置机器的输出音量。

音量设置可以从0~10之间11个数值选择，按“◀”或“▶”键选择合适的音量值，选择完成后按菜单键确定。

12.4.8 循环录像

在录像设置菜单中，选择“循环录像”菜单，再按菜单键进入循环录像菜单。有关闭和打开两种选择，按“◀”或“▶”键进行选择，选择完成后按菜单键确定，长按菜单键返回上一级菜单。

参考界面如下图所示：



12.4.9 车载录音

使用此功能，你可以选择是否需要录下车内的声音。

12.4.10 分段录像

视频分段有1分钟、5分钟、10分钟、15分钟、20分钟、30分钟六个级别，在录像过程中，视频分段在所设定的时间自动将视频文件分段保存并自动进入下一个文件录像，并且是无缝切换。视频分段功能参考界面如下图所示：



12.4.11 按键音

使用此功能，按键操作将会有声音提示。

12.4.12 指示灯

使用此功能，你可以根据需要打开或者关闭状态指示灯。

12.4.13 移动侦测

音视频记录仪在待机状态下，有物体进入音视频记录仪拍摄范围内后自动开启录像功能，物体离开音视频记录仪拍摄范围后结束录像功能并保存录像文件。移动侦测功能设置可选择：关闭 / 开启。

12.4.14 曝光补偿

曝光补偿是一种曝光控制方式，曝光补偿可以让照片更明亮或者更昏暗的拍摄手法。可以根据自己的想法调节照片的明暗程度，创造出独特的视觉效果等。

曝光补偿设置可以从 $-2.0 \sim +2.0$ 之间13个数值选择，按“◀”或“▶”键选择合适的曝光值，选择完成后按菜单键确定。

12.4.15 ID号

ID号设置界面，参考图片如下：



在此界面下，按菜单键与“◀”或“▶”键可以设置机器的设备编号和用户编号。按“◀”或“▶”键改变相应位置数值，短按菜单键确认，长按菜单键返回上一级菜单。

12.4.16 系统信息

系统信息菜单中包括：总存储容量，可用空间，可用录像时间，可用录音时间，电池电量和版本号。

总存储容量：本机内存大小信息。

可用空间：剩余空间信息。

可用录像时间：当前录像分辨率可录像时长。

可用录音时间：当前录音类型可录音时长。

电池电量：当前电池电量信息。

版本号：固件版本信息。

13 背夹的装取

- ①装背夹时将背夹插片的 R 位导入主机槽口后，缓慢推进背夹直至插片顶到插槽底部为止
- ②拆背夹时，一手握住背夹，一手握住主机并扶住插片，轻缓拔出即可。如下图所示：

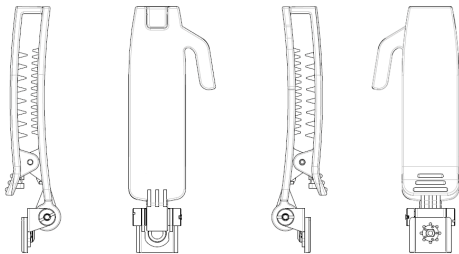

取出背夹时按相反的方向并加向上的力拉出。

14 常见问题

此处列举了常见问题的解答，可帮助解决音视频记录仪出现的简单问题。如果故障仍无法排除，请咨询经销商或访问我们的官方网站：www.philips.com/support

14.1 无法启动音视频记录仪

电池电量已耗尽请及时充电。

14.2 显示时间 / 日期不正确

音视频记录仪时间不准确，请在菜单上重新设置时间。

14.3 拍照 / 录像图像模糊，不清楚

镜头不干净。请用干净的绒布清洁镜头。

14.4 音视频记录仪无法录音或者录像

音视频记录仪存储空间已满并且未开启循环录像。请删除部分文件或将其移至外部存储设备。

14.5 音视频记录仪无法播放录音或者录像

电池电量已耗尽，请充电。

14.6 音视频记录仪死机后如何处理

你有时在操作中会遇到开不了机，黑屏，操作不了等死机现象，通常处理方法是，复位一下，复位键位置：打开 USB 盖，槽内有一个小孔，用镊子或尖的东西点按一下小孔即可。

注：本操作不会造成文件数据丢失或者损坏。

15 技术参数

15.1 存储器

外置存储空间

参考录音时间（16GB）：录音时间约 290 小时

内置存储器类型：C10 TF 卡

移动存储器（PC）：是

15.2 尺寸和重量

宽 × 高 × 深：56×78×25（mm）

重量（含电池）：110g（不含背夹）

15.3 系统要求

操作系统：Windows 7/8/10/Vista/XP/2000, Mac OS X, Linux

接口：USB 接口

15.4 录音

单声道：比特率为 128kbps，格式为 MP3

15.5 运行条件

温度：-10℃ ~ 55℃

空气湿度：10% - 90%，不凝结

Content

1	Welcome	28
1.1	Product features	28

2	Important Notice	29
2.1	Safety	29

3	Your Audio/Video Recorder	30
3.1	What's in the box	30
3.2	Overview of your audio recorder	30

4	Start to Use	32
4.1	Turn ON/OFF	32
4.2	Charging methods	33
4.3	Connecting to computer	33

5	Video Recording	34
---	-----------------	----

6	Current Video Duration	35
---	------------------------	----

7	Photo	36
---	-------	----

8	Voice Recording	37
---	-----------------	----

9	Video Mode	39
9.1	Video playing	39

10	Photo Mode	41
----	------------	----

11	Audio Mode	42
11.1	Voice play	43

12	Setting Mode	44
12.1	Voice recording	44
12.2	Recording setting	44
12.3	Photo setting	45
12.4	System setting	46

13	Mounting of Shoulder Clip	51
----	---------------------------	----

14	FAQ	52
14.1	Unable to start audio and video recorder	52
14.2	Incorrect time/date	52
14.3	Unclear image	52
14.4	Fail to record audio/video	52

14.5 Unable to play audio or video files	52
14.6 How to respond to recorder failure	52

15 Technical Parameters	53
15.1 Memory	53
15.2 Dimensions and weight	53
15.3 PC Interface	53
15.4 Voice recording	53
15.5 Operating conditions	53

I Welcome

Welcome to the world of Philips! We are honored by your choice and purchase of Philips' products. You can have Philips' comprehensive technical supports from our website, e.g. user's manuals, software downloading and warranty information etc.

www.philips.com

1.1 Product features

- Quick Voice Recording: Simply press the Voice Recording button for the first time to record, and the second time to save recorded clips.
- Quick Video Recording: Simply push the Video Recording button up for the first time to record, and pull the button down to save the recorded clips.
- Super-wide angle lens to get a fuller picture.
- F1.6 super-wide angle lens with more charge to get a clearer picture.
- Starlight-level night vision to formulate color imaging in low-light environments to get a clear and visible picture.
- Toggle switch to be safe, flexible, stable and reliable in performance.
- On-Screen Display function ensures that all videos and photos contain un-editable timing, product serial number and user serial number that ensure legal validity of such evidence.
- Super long file name: All recorded video files contain information such as product serial number, recording time and user serial number, which ensure convenient data storage and retrieval.
- All recorded video files are automatically cut and saved to prevent data loss due to incorrect operation.
- External memory card supports 128G.
- High-definition speaker: Use high-quality speaker to give you a live feel during audio or video play.
- Record in a common MP3 format.
- Access to the audio file and data by using high-speed USB 2.0.
- It is able to be used as a large capacity USB storage device to ensure the maximum compatibility.
- The damper shaft back clip can be adjusted at any angle, which is flexible and reliable to wear.

2 Important Notice

2.1 Safety



Notice

- Protect the cables from being pinched, particularly at plugs.



Warning

Special Announcement: Before using the product, please read the Manual carefully. The Company shall not be held liable for any data loss due to incorrect manual operation or force majeure. We specially recommend that users make additional copies of the files in the device.

3 Your Audio/Video Recorder

3.1 What's in the box



3.2 Overview of your audio recorder

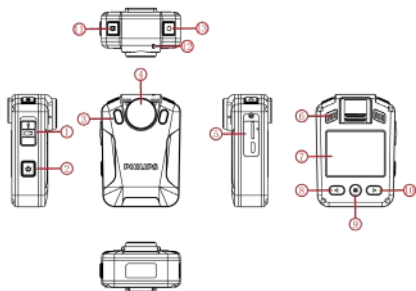

- ① Video recording button
- ② Power on / off
- ③ Additional light
- ④ Lens
- ⑤ USB interface / TF card socket / reset
- ⑥ Loudspeaker
- ⑦ Screen
- ⑧ Up / FB
- ⑨ Menu key / Back Key
- ⑩ Down / FF
- ⑪ Photo button
- ⑫ Working indicator
- ⑬ Recording button

4 Start to Use

4.1 Turn ON/OFF



Notice

- Please recharge the device for three hours before using it for the first time!

During shutdown mode, long press Turn ON button for 3 seconds, and the device will be turned on, showing the Philips logo, as shown below:



Then the device enters the preview interface, as shown in the figure below. In the preview state, the working indicator lights up in green. On this interface, press the menu button and the device returns to the setting interface. Long press

'◀' or '▶' to zoom in or out on the preview interface for digital zoom.



Notice

- This device is powered by a non-removable lithium battery. If you do not use the audio and video recorder for a long time, long press the power button for 3 seconds to turn off the device.
- If the record does not work properly, please check if the device is out of power.
- During the operation please do not pull out the external memory card. Otherwise, damage might be caused to the files or the device.
- When the battery sign shows this '🔋', please charge your device in time.

4.2 Charging methods

- (1) Use USB cable to connect the device with PC, the indicator will show green light during charging.
- (2) Use USB cable and the connector to charge the device. The device indicator will show green light first, which will be extinguished after the device is fully charged.



Reminder

- The device can be charged either during ON or OFF mode. Normally, during OFF mode charging, it takes around 4 hours for full charging. During ON mode, it takes around 6 hours for full charging (we recommend that you use OFF mode charging).



Reminder

- When the file are moved from the PC to the VideoTracer, please do not disconnect the device from the PC.

4.3 Connecting to computer

The recorder can be used as a large-volume USB storage device, which can be connected to the computer. No software needs to be installed for VTR8101. The recorder will be shown as a portable device. The icon of connecting to computer is shown in the figure below.

5 Video Recording

When you use the recorder for the first time, please pay attention to the requirements in this section!

- (1) In the camera preview state, push the Video button up to start the video recording. The device makes the sound of 'tick' and the status indicator will flash in red.
- (2) Pull the Video button down to end the recording. The device 'tick' for two times, the red indicator light goes out, the device returns to the camera preview interface, and the status indicator lights up in green.
- (3) Long press '◀' or '▶' on the preview interface to zoom in or out on the preview interface for digital zoom.
- (4) When recording in dark or dim light, long press Recording Button to turn on the illumination light.
- (5) Press the 'Photo' button to capture the current recording screen.
- (6) Long press the photo button during video recording. The file will be marked as important file, and the marked file will not be deleted when the loop video files are turned up.
- (7) The reference video recording interface is shown below:



Recording Interface Illustration



- | | |
|--------------------------------|------------------|
| ① Recording resolution | ② Video icon |
| ③ System current date and time | ④ ID watermark |
| ⑤ Recording mode | ⑥ Video duration |
| ⑦ Battery | ⑧ System time |
| ⑨ Remaining card capacity | ⑩ Card icon |

6 Current Video Duration

Notice

- When the battery icon is showing empty, it means low on battery. When the low battery icon occurs, the system will automatically shut down. If you are recording, the system will automatically save the recorded files then shut down. In case of low battery, please charge your device timely. During low battery, the device gives you 'Low Battery' notice as shown below.



Reminder

- Before recording, please adjust the recording parameters first.
- Please delete some unnecessary files before recording.

7 Photo

When you use the device for photo taking for the first time, please read the instructions in this section! In the camera preview state, directly press the camera button to take a photo. In the state of photo taking, the red indicator lights on, and the device makes a sound of 'beep'. In the dark night or in a dark environment, the device additional light needs to be turned on for shooting (Additional light: In the preview interface, long press the recording button to turn on the additional light, then long press to turn off it. The light icon will be displayed in the upper left corner of the preview interface after the additional light is turned on, as shown in Figure 2). In the video recording state, press the camera button to capture the picture at the time. The interface of which is shown as Figure 1.



Figure 1



Figure 2

8 Voice Recording

When you use the device for audio recording for the first time, please read the instructions in this section!

(1) Press the 'Voice button' in the video preview state to start recording; the working indicator lights on in yellow; please point the built-in microphone to the voice source.

(2) Press the 'Voice' button to end the recording and return to the preview interface.

The recording interface is shown below:



Audio recording interface



- ① Recording status
- ② Current recording duration
- ③ Battery status



Reminder

- Before recording, please adjust the desired recording sensitivity.
- Please delete some unnecessary files before recording.
- Please test the voice recording first to confirm that the audio and video recorder settings are correct.
- Do not pull out the memory card during audio/video recording mode. Otherwise, damage might be caused to the files.
- Do not cut off power during audio/video recording mode. Otherwise, damage might be caused to the recorder and the files might be lost or damaged.
- If you intend to use the device for a long period of time, please charge the device before recording.

9 Video Mode

On the camera preview status interface, we can use the '◀' button to enter the review playback interface, press '◀' or '▶' to select the video option, and then press the menu button to confirm the video file list interface. The video file list reference interface is shown below:

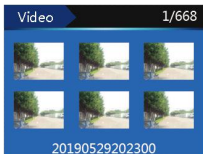

Press '◀' or '▶' to select the video file. Press the menu button to enter the video playback interface. The video playback reference interface is as shown below:



The deletion of the file can be done by connecting to a computer.

Recorded File Playing Illustration:

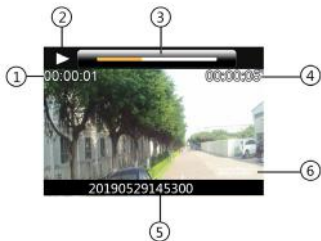

- ① Current duration
- ② Current play state
- ③ Progress bar
- ④ Total file length
- ⑤ File name
- ⑥ ID watermark

9.1 Video playing

- (1) Press '◀' or '▶' to select the file you need to play.
- (2) Press the 'Menu' button to start playback, and the working indicator will light on in green.
- (3) During playback, press the 'Menu' button to pause playback, press the 'Menu' button again, and the playback

will return to the previous position.

- (4) Press '◀' or '▶' during playback to select 2 times, 4 times, 8 times, 16 times, 32 times, 64 times, 128 times to fast backward or fast forward the currently playing file.

10 Photo Mode

In the camera preview status interface, the '◀' button can be used to enter the review playback interface. Press '◀' or '▶' button to select the camera option, then press the menu button to enter the camera file list interface. The camera file list reference interface is shown below:

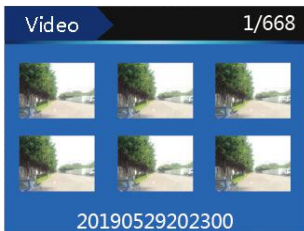

Press '◀' or '▶' button to select the photo file to be played; press the menu button to enter the photo browsing state, press '◀' or '▶' to switch the photo.

II Audio Mode

In the camera preview state, you can use the '◀' button to enter the review playback interface, press the '◀' or '▶' button to select the voice recording option, and then press the menu button to enter the voice file list interface. The voice file list reference interface is as shown below:

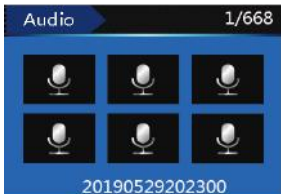

Press the '◀' or '▶' button to select the audio file to be played; press the menu button to enter the voice playback interface. The voice playback reference interface is as shown below:

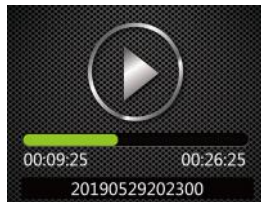

Audio File Playing Interface Illustration:

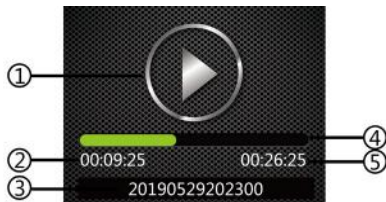

- ① Current play state
- ② Current play time
- ③ Time file name
- ④ Play progress bar
- ⑤ Total file length

11.1 Voice play

- (1) Press '◀' or '▶' button to select the file you want to play.
- (2) Press the 'Menu' button to start playback, the working indicator will light on in green.
- (3) During playback, press the menu button to pause playback and press the menu button again to resume playback.

12 Setting Mode

Press the menu button in the camera preview status interface, the system will enter the setting interface. System settings include: voice recording setting, video recording setting, camera setting and system setting.

Press the '◀' or '▶' button to select and press the menu button to enter the selected option. Long press the 'Menu' button to return to the preview interface.

12.1 Voice recording

Press 'Menu' to enter the setting mode, press '◀' or '▶' to select the voice recording setting menu, press 'Menu' to select, and the options of high, medium and low will pop up. Select different levels of microphone sensitivity to achieve different recording effects.

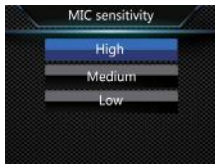

12.2 Recording setting

The video settings menu includes: resolution, video quality, video pre-recording, video delay recording. Press '◀' or '▶' to select the option you want to set, and then press the menu button to enter.

11.2.1 Resolution

Video resolution is of four levels, namely 1920×1080 30P, 1440×1080 30P, 1280×720 30P, and 848×480 30P. Different video resolution options can meet the requirements in most application occasions. Press '◀' or '▶' to select appropriate resolution. Press the menu button when the selection is completed, and long press the menu button to return to the previous menu.

The reference interface is shown below:



12.2.2 Video quality

There are three quality options to choose from on the Video Quality menu: 'Highres', 'Good', 'Normal'. According to different needs, different quality effects are selected. The better the video quality, the larger the memory occupied by the same video length.

12.2.3 Video pre-recording

Apply the video pre-recording function to start the recording around the first ten seconds, before the record button is activated. The video pre-recording has two options: off and on. Press '◀' or '▶' to select, and press the menu button to confirm. Long press the menu button to return to the previous menu.

Pre-recording time: about 16 seconds.

12.2.4 Delayed recording

Apply the delayed recording function to continue the recording for a certain time after pushing the button to save the recording. There are five options for delayed recording: setting off, 5 sec, 10 sec, 20 min, 30 min. Press '◀' or '▶'

to select and press the menu button to confirm after the selection is completed. Long press the menu button to return to the previous menu.

12.3 Photo setting

The photo settings menu includes: photo size, photo quality, and continuous shooting. Press '◀' or '▶' to select the option you want, and then press the menu button to enter.

12.3.1 Photo size

The sizes of the photos are of 34M, 28M, 23M, 18M, 13M, 9M, 6M, and 4M. Press '◀' or '▶' to select the appropriate resolution. After the selection is completed, press the menu button to confirm. Long press the menu button to return to the previous menu. The reference interface is shown below:



12.3.2 Photo quality

There are three quality options to choose from on the Photo Quality menu: 'Highres', 'Good', 'Normal'. According to different needs, different quality effects are selected. The better the picture quality, the larger the memory occupied by the photo.

12.3.3 Continuous shooting

Continuous shooting means press the photo button to take photos during preview or recording mode.

On the camera setting menu, select 'Continuous Shooting' and press the menu button to enter. Press '◀' or '▶' to select. Press the menu button to confirm after the selection is completed. Long press the menu button to return to the previous menu.

12.4 System setting

System settings menu includes: language, default settings, screen brightness, system time, auto power off, auto screen off, volume, car mode, loop video, car recording, segmented video, button tone, indicator light, motion detection, exposure compensation, ID number and system information. Press

'◀' or '▶' to select the option you want to set, and then press the menu button to enter.

12.4.1 Language

In the language selection menu, you can select a language as the system language. The reference interface of language selection is as follow:



12.4.2 Default settings

Apply the function to reset the device's setting options.

12.4.3 Brightness

When you want to use this function, you can adjust the

brightness of the screen. The screen brightness can be set to three levels: high, medium and low. Press '◀' or '▶' to select the appropriate option. Press the menu button to confirm after the selection is completed. Long press the menu button to return to the previous menu.

12.4.4 System time

The system time setting interface is as shown below:

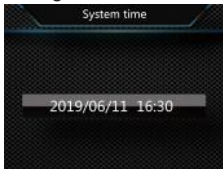

On this interface, press the menu button and '◀' or '▶' to set the real time. Press '◀' or '▶' to change the value. Press the menu button to confirm after the selection is completed. Long press the menu button to return to the previous menu.

12.4.5 Auto off

If there is no operation on the device, the VideoTracer

automatically shuts down after a certain period of time. The interface looks like following:



12.4.6 Auto screen off

There are four options for the auto screen off time: Off, 30 seconds, 1 minute, 3 minutes. If no operation is done to the device within the given time, the screen will black out. If 'Off' is selected, the display will be constantly lit.

12.4.7 Volume

When you use this function, you can adjust the volume of the device.

The volume setting can be selected from 11 values between 0 and 10. Press '◀' or '▶' to select the appropriate volume value. After the selection is completed, press the menu button to confirm.

12.4.8 Loop video

On the video settings menu, select 'Loop video' and press the menu button to enter. Press '◀' or '▶' to choose from the two options: on and off. After the selection is completed, press the menu button to confirm. Press the menu button to return to the previous menu.

The reference interface is shown below:



12.4.9 Car recording

When the function is used, you can choose whether you want to record the sound inside the car.

12.4.10 Segmented video

The segmented video has six levels: 1 minute, 5 minutes, 10 minutes, 15 minutes, 20 minutes, and 30 minutes. During the recording process, the segmented video automatically saves the video file in segments and automatically switches to the next video recording.

The video segmentation function reference interface is shown below :



12.4.11 Key sound

When the function is used, there will be an audible prompt for button operation.

12.4.12 Indicator light

When the function is used, you can turn on or off the status indicator as needed.

12.4.13 Motion detection

In the standby state, the audio and video recorder automatically turns on the recording function after an object enters the shooting range of the audio and video recorder. After the object leaves the shooting range, the recording function ends and the recording file is saved. The motion detection function setting can be selected: off / on.

12.4.14 Exposure compensation

Exposure compensation is an exposure control method that compensates for brighter or darker shots. You can adjust the brightness of your photos to create unique visual effects according to your own needs.

The exposure compensation setting can be selected from 13 values between -2.0 and +2.0. Press '◀' or '▶' to select the appropriate value. When the selection is completed, press the menu button to confirm.

12.4.15 ID number

ID number setting interface is as shown below:

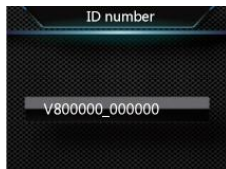

On this interface, press the menu button and '◀' or '▶' to set the device number and user number. Press '◀' or '▶' to change the corresponding position value, and press the menu key to confirm. Long press the menu to return to the previous menu.

12.4.16 System information

The system information menu includes: total storage capacity, available space, available video time, available audio time, battery power and version number.

Total storage capacity: local memory size information.

Available space: remaining space information.

Available video time: the time length for the current video recording resolution.

Available audio time: the time length for the current audio recording type.

Battery level: current battery level information.

Version number: Firmware version information.

13 Mounting of Shoulder Clip

- ① When mounting the shoulder clip, introduce the R of the clip into the main slot, and then slowly push it until the top of the clip reaches the bottom of the slot.
- ② When removing the shoulder clip, hold it with one hand, hold the device body with the other hand and hold the clip. Gently pull it out. It is as shown below:

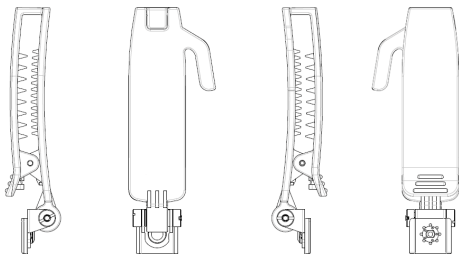

Pull out the clip in the opposite direction and pull it out with the upward force.

14 FAQ

This section has listed all the frequently asked questions to help you address the simple issues during use of the voice/video recorder. If such issues persist, please consult our dealers or visit our official website: www.philips.com/support

14.1 Unable to start audio and video recorder

The batter has run out and you need to charge your device.

14.2 Incorrect time/date

The audio and video recorder time is not accurate, and please reset the time on the menu.

14.3 Unclear image

Unclean lens has caused it. Please use clean cloth to clean it.

14.4 Fail to record audio/video

The internal storage of audio/video recorder has run out and

no recycling shooting mode has been turned on. Please delete some of the files or transfer such files to external storage device.

14.5 Unable to play audio or video files

The batter is used up, please charge your device.

14.6 How to respond to recorder failure

Sometimes you will encounter in the operation the problems such as failure to power on or black screen, etc. The usual processing method is to reset it. The position of the reset button: open the USB cover, and you'll find a small hole in the slot; use tweezers or pointed item to click on the hole.

Note: This operation will not cause data loss or destruction.

15 Technical Parameters

15.1 Memory

External Memory

Recording time reference(16GB): about 290 hours

Type of Internal Storage: C10 TF card

Mobile storage device (PC): Yes

15.2 Dimensions and weight

Width × Height × Depth: 56×78×25 (mm)

Weight (with battery): 110g (without back clip)

15.3 PC Interface

Operating System: Windows 7,8,10/Vista/XP/2000, Mac OS X,
Linux

Port: USB

15.4 Voice recording

Mono: The bit rate is 128kbps, and the format is MP3

15.5 Operating conditions

Temperature: -10°C ~55°C

Air humidity: 10% – 90%, non-condensing

Warranty card

质保书

1

year warranty

一年质保

Type: VTR8101

Serial nr:

Date of purchase

购买日期

Dealer's name, address and signature

销售商名称、地址及签字

www.philips.com/welcome

This document is printed on chlorine free produced paper

Data subject to change without notice

This product was brought to the market by Speech Processing Solutions GmbH or one of its affiliates, further referred to in this document as SPS, which is the manufacturer of the product. SPS is the warrantor in relation to the product with which this booklet was packaged.

For China only
只限中国地区

Printed in China



